

Operating Instructions

Single/Dual Bourdon Tube Pressure Switches Type BS/BT/BX



1	Intended Applications	2
2	Safety Instructions.....	2
3	Standards	3
4	Warranty/Guaranty.....	3
5	Installation/Commissioning	4
6	Maintenance/Cleaning	8
7	Technical Data.....	8

Barksdale GmbH

Dorn-Assenheimer Straße 27
D-61203 Reichelsheim

Phone: +49 (6035) 949-0
Fax: +49 (6035) 949-111 and 949-113
email: info@barksdale.de
Internet: www.barksdale.de

Art. no.: 923-0158
Index Q, 26.08.2022
Specifications are subject
to changes without notice!



1 Intended Applications

The pressure switches are specifically applied for monitoring and controlling of operations using maximum and minimum pressures. A micro switch triggers an electrical signal when minimum or maximum pressure are reached.

DANGER

The switch may only be used in the specified fields of application (see type label).

The temperature has to be within the specified ranges, the pressure values and the electrical rating must not exceed the values specified.

Observe also the applicable national safety instructions for assembly, commissioning and operation of the switch.

The switch is not designed to be used as the only safety relevant element in pressurized systems according to PED 2014/68/EU.

Without special provisions/actions, pressure switches must not be used for pure hydrogen applications.

2 Safety Instructions

The safety instructions are intended to protect the user from dangerous situations and/or material damage.

In the operating instructions the seriousness of the potential risk is designated by the following signal words:

DANGER

Refers to imminent danger to men.
Nonobservance may result in fatal injuries.

WARNING

Refers to a recognizable danger.
Nonobservance may result in fatal injuries, and destroy the equipment or plant parts.

CAUTION

Refers to a danger.
Nonobservance may result in light injuries and material damage to the equipment and/or to the plant.

IMPORTANT

Refers to important information essential to the user.

Disposal

The equipment must be disposed of correctly in accordance with the local regulations for electric/electronic equipment.
The equipment must not be disposed of with the household garbage!

3 Standards

The standards applied during development, manufacture and configuration are listed in the CE conformity and manufacturer's declaration.

4 Warranty/Guaranty

Warranty

Our scope of delivery and services is governed by the legal warranties and warranty periods.

Terms of guaranty

We guaranty for function and material of the single- / dual- pressure switch under normal operating and maintenance conditions in accordance with the statutory provisions.

Loss of guaranty

The agreed guaranty period will expire in case of:

- changes or modifications to the switch/housing/fitting
- incorrect use,
- incorrect installation or
- incorrect handling or operation contrary to the provisions of these operating instructions.

No liability is assumed for any damage resulting therefrom, or any consequential damage.

5 Installation/Commissioning

 DANGER
<p>Only install or uninstall the switch when deenergized (electrically and hydraulically/pneumatically).</p> <p>Pressure connection and electrical connection must be carried out by trained or instructed personnel according to state-of-the-art standards.</p> <p>The switch must only be installed in systems where the maximum pressure P_{max} is not exceeded (see type label).</p>

 WARNING
<p>Pressure peaks and pressure shocks exceeding the maximum operating pressure are inadmissible.</p> <p>The maximum operating pressure is the upper final value of the adjustable range or, if specified, the pressure indicated as maximum operating pressure. Exceeding the max. operating pressure affects the performance and the life span of the product and may damage it.</p> <p>Install the pressure switch as far as possible free from vibration, since otherwise the switching accuracy might be impaired.</p>

 WARNING
<p>Check the switch regularly for functioning.</p> <p>If the switch does not work properly, stop operation immediately!</p>

 IMPORTANT
<p>All pressure switches are tested for proper functioning before they leave the factory. The factory proof pressures are stated on the type label.</p>

Contact Protection

The micro switches used are normally suitable for both direct and alternating current operation. Inductive, capacitive and lamp loads may, however, considerably reduce the life expectancy of a micro switch and, under extreme circumstances, even damage the contacts.

Depending on the application spark suppression and current limiting is recommended (see succeeding figures).

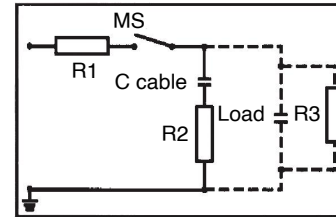

Fig. 1: Protection in case of capacitive loads
R1: Protection against starting current rushes R2,R3: Protection against high discharge currents

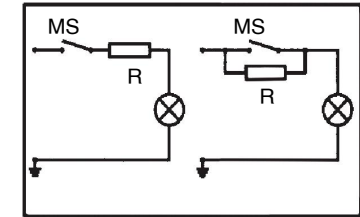

Fig. 2: Lamp load provided with resistance in parallel or series connection to switch of condensators

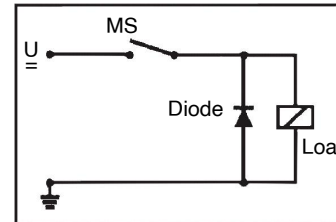

Fig. 3: Protection in case of continuous current and inductive load by recovery diode

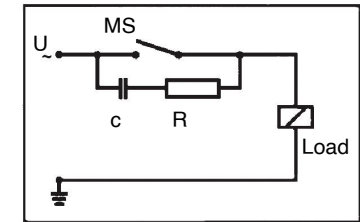



Fig. 4: Protection in case of alternating current and inductive load by RC-link

Set point adjustment

 IMPORTANT
<p>Factory-Provided: pressure (temperature) switch point setting</p> <p>We confirm for pressure (temperature) switches that have been factory set the setting will be detailed on the label name plate.</p> <p>Warranty is not applicable for any changes that may occur due to transportation or installation.</p> <p>For critical applications we recommend the setting is checked and re-set if necessary after installation and wiring of the pressure (temperature) switch.</p>

In pressure switches, a displacement of the pressure sensing element occurs with a change in pressure. Following the displacement of the pressure sensing element operates a microswitch. Upon delivery of the product, the set points are likely to be found in the middle of the adjustable range. On request, fix set points may be adjusted by our factory. In this event, the point will be indicated on the type plate or any separate plate, i = increasing, d = decreasing.

The set point is adjusted by turning the adjustment screw.

 IMPORTANT
To reach the adjustment screw for pressure switches with housing, remove the cover.

Allow pressure switch to reach the desired switch pressure.

Turn adjustment screw clockwise or counterclockwise to actuate the micro switch.

 IMPORTANT
+ ↺ - Counterclockwise rotation: set point increasing
Clockwise rotation: set point decreasing

 IMPORTANT
Please consult the wiring diagram for the contact status at atmospheric pressure (see Fig. 5).

Precise adjustment of set point to actuate on increasing pressure

- Lower system pressure to 0 bar.
- Increase pressure slowly and check if micro switch is actuated at desired switch pressure.
- If necessary, readjust by turning the adjustment screw
- Repeat preceding steps until microswitch operates at desired switch pressure.

Precise adjustment of set point to actuate on decreasing pressure

- Increase pressure up to a point clearly above the desired switch pressure (at least, switch pressure plus max. hysteresis; not above max. operating pressure).
- Lower pressure slowly and check if micro switch is actuated at desired switch pressure.
- If necessary, readjust by turning the adjustment screw
- Repeat preceding steps until microswitch operates at desired switch pressure.
- Following the adjustment of all set points, each set point must be checked and, if necessary, be readjusted.

 IMPORTANT
The adjustment of several set points occurs for each set point as specified above.

Wiring Code for all Types (Contact status at atm. pressure)

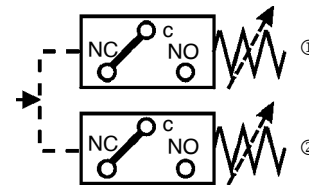

Power circuit ①	Power circuit ②
C = purple	C = brown
NC = blue	NC = orange
NO = red	NO = black

at vacuum NC/NO vice versa

Fig. 5: Wiring Code

Use in Hazardous Locations

There are two housing designs for use in hazardous locations. The BX version with an explosion-proof enclosure for **Ex d** applications. The Bourdon tube pressure switches with T and X housing are approved for use in intrinsically safe circuits as **Ex ia**. The intrinsically safe units marked as **Ex i** must be operated with a certified switch amplifier (see Fig. 6).

The B1S/B2S pressure switch has none of the aforementioned ATEX approvals. BX pressure switches with explosion-proof enclosures are designed and certified to be used according to UL, CSA, Nema 4, 7, 9 or ATEX regulations. The wiring between switch and **Ex i** isolation amplifier must meet the local safety requirements. The customer must provide for a highly conductive connection between switch and grounding.

 WARNING
With option Ex i: The models having light-alloy (aluminium) enclosures or enclosure parts must be protected against all impact or friction which can ignite the explosive atmosphere.

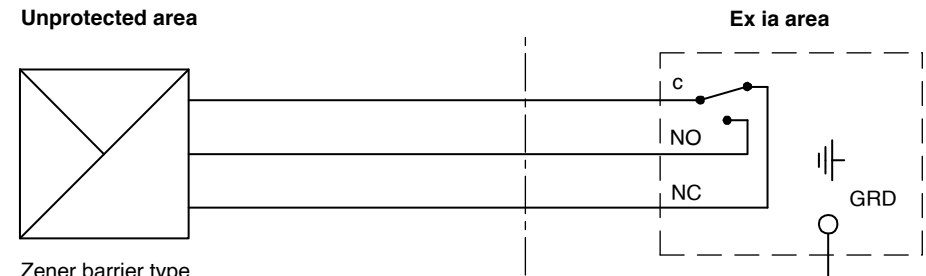

Zener barrier type
Switch amplifier NAMUR

Fig. 6: Operation of pressure switches in intrinsically safe areas

6 Maintenance/Cleaning

Maintenance

The pressure switch is maintenance free. Checking the set points lies within the discretion of the user. The usual preventive maintenance work in accordance with the PED and ATEX guidelines must always be carried out.

Please note that small setpoint drifts may occur during the initial use of the switch (run-in period). To minimize the setpoint drift we can perform a run-in (ageing) process in our works on request. Larger or continuing setpoint drifts during the normal use of the switch may indicate that the measuring system is not used correctly within the specified limits, exceeding the design criteria or is worn-out. This might lead to metal fatigue of the measuring system and it therefore should be replaced before an ultimate rupture of the metal diaphragm might take place. Please consult your supplier or Barksdale directly for guidelines.

7 Technical Data

See data sheet

Dimensions in mm (inch)

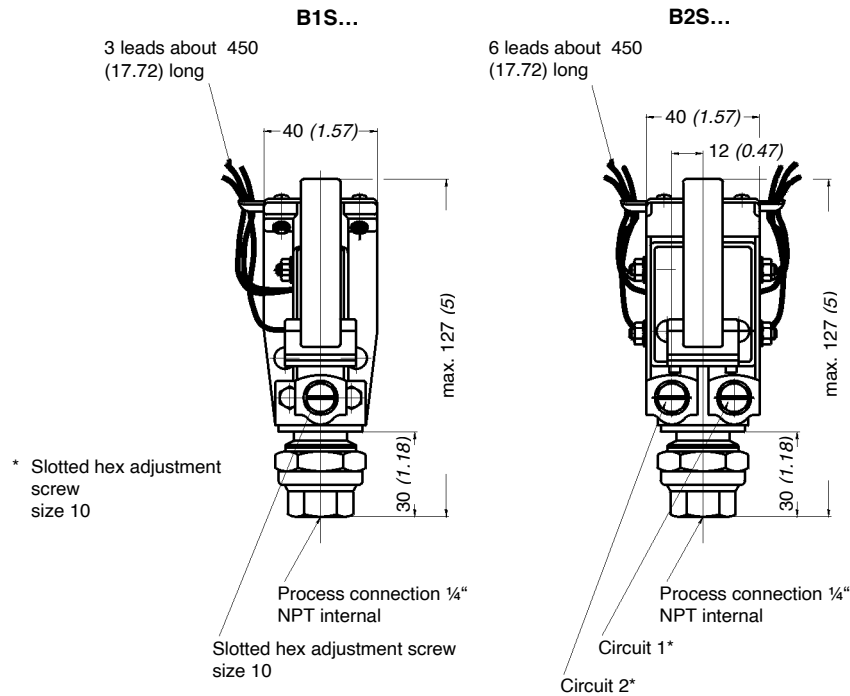

Fig. 7: Bourdon tube pressure switch type B1S .../B2S ...

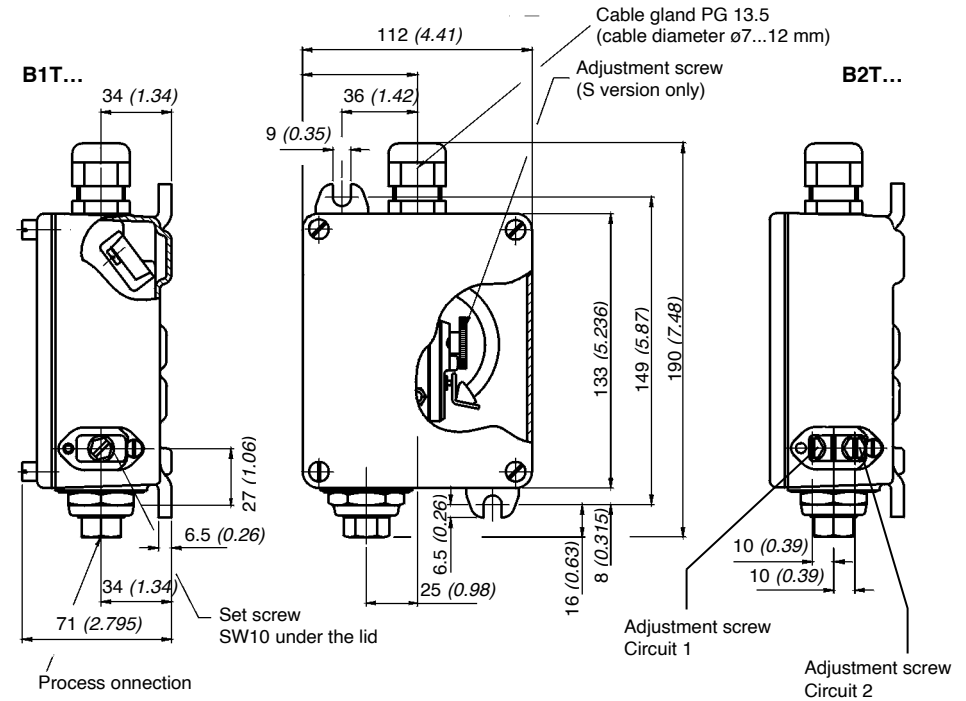

Fig. 8: Bourdon tube pressure switch type B1T .../B2T ...

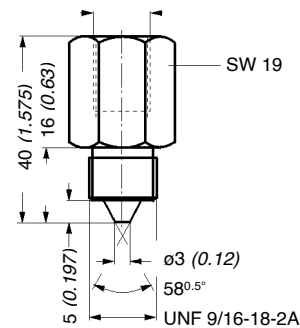





Fig. 9: Adapter, adjustable ranges*) see section Adjustable Ranges Pressure Switch Type B1S.../B2S... and Type B1T.../B2T... and Adjustable Ranges Pressure Switch Type B1X.../B2X...

Approval data for Ex i switches (B1T, B2T and B1X, B2X)

Approval:	 II 1 G Ex ia IIC T6 Ga II 1 D Ex ia IIIC T ₂₀₀ 100°C Da
Certificate no.:	TÜV 20 ATEX 322922X, IECEx TUN 21.0011X
Permissible ambient temperature:	40 °C ≤ Ta ≤ +75 °C
Electrical data for intrinsically safe application:	Ui = 28 V li = 50 mA Pi = 0,84 W Ci, Li negligibly small
Standards applied:	EN IEC 60079-0: 2018/AC:2020-02, IEC 60079-0:2017, EN 60079-11:2012, IEC 60079-11:2011

Approval data for Ex i switches B1T with connector ST1, and B2T with connectors ST1, ST3

Approval:	 II 1 G Ex ia IIB T6 Ga II 1 D Ex ia IIIC T ₂₀₀ 100°C Da
-----------	---

 CAUTION
<p>Special conditions for use:</p> <ol style="list-style-type: none"> The size of the nameplate exceeds the permissible area and can therefore be electrostatically charged: For IIC Ga uses the pressure switches have to be installed and used in such a way, that electrostatic charging from operation, maintenance and cleaning is excluded. For the use in explosive dust atmospheres process-related electrostatic charges, e.g. due to passing media have to be excluded. All metallic parts of the devices have to be included in the local potential equalization. The intrinsically safe circuit of the device is connected to the earth potential, therefore potential equalization has to exist in the entire area of the installation of the intrinsically safe circuit. The housings of the devices consist of more than 10% aluminum, therefore in EPL Ga applications the installation has to be carried out in such a way, that ignition hazard due to impact or friction can be excluded.

 CAUTION
<p>No inadmissible heating can be expected that affect the maximum surface temperature. The maximum surface temperature lies only a small amount above the permissible ambient temperature during operation.</p>

Approval data for Ex d switches (BX)

Approval:	 II 2 G Ex db IIC T6 Gb II 2 D Ex tb IIIC T80°C Db IP66
Permissible ambient temperature:	-40 °C ... +75 °C

Approval data for Ex d switches (BX-option "LT")

Approval:	 II 2 G Ex db IIC T5 Gb II 2 D Ex tb IIIC T95°C Db IP66
Permissible ambient temperature:	-60 °C ... +85 °C
Certificate no.:	ISSeP08ATEX024X/3
Standards applied:	EN 60079-0:2012 + A11:2013 EN 60079-1:2014 EN 60079-31:2014

Operating life time

Normal expected service life (expressed in the number of cycles over the full adjustment range) is appr. 1 million for the pressure switch. This may be extended to 2.5 million cycles max. if only a part of the adjustment range is used (about 20%).

Switch sensor life may also be effected negatively by:

- Media not compatible with the wetted materials.
- Too high switch cycling speed or more than 20 cycles per minute.
- System cycling pressure exceeding the top of the adjustable range.

The proof pressure must never be exceeded to avoid permanent sensor damage. Matching the working range of the switch to the application is also a key for optimal switch performance. For greatest accuracy the set point should fall in the upper 70% of the adjustable range. For most favourable life the set point should be in the lower 30% of the adjustable range. Therefore, the most favourable combination of accuracy and life factor lies between 30% and 70% of the adjustable range.