

**Dimensions UNS1000**

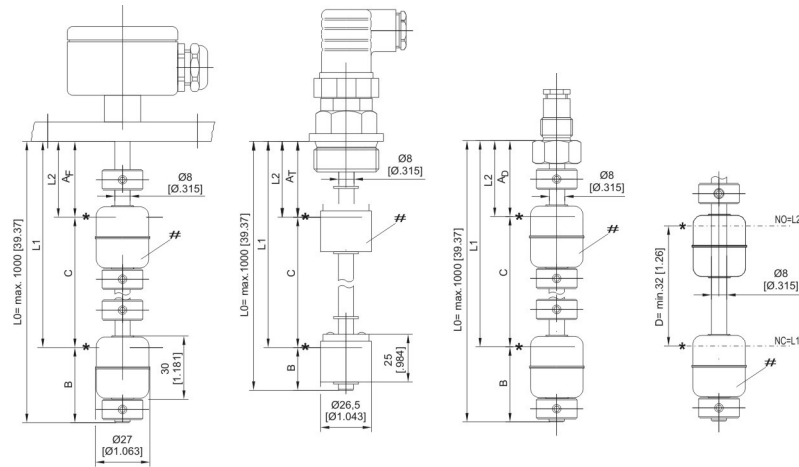

**Dimensions UNS2000**

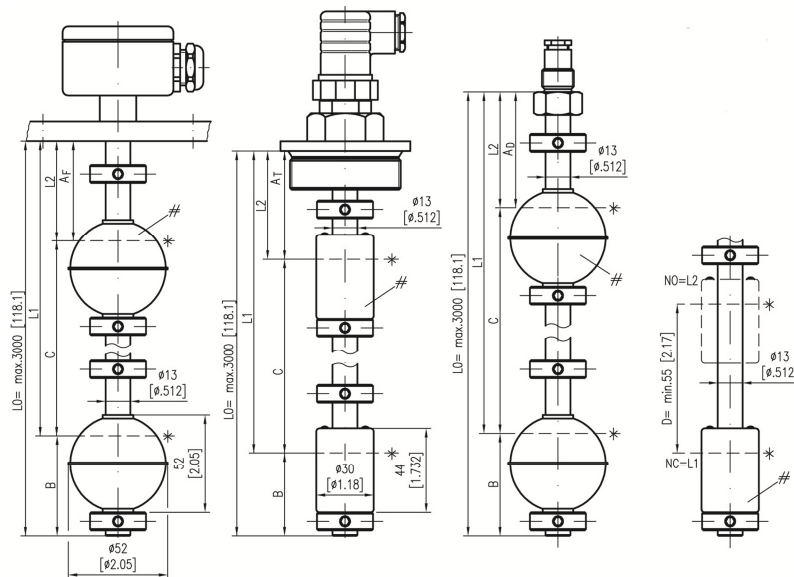

**Operating Instructions**  
**Level Switch Type UNS**

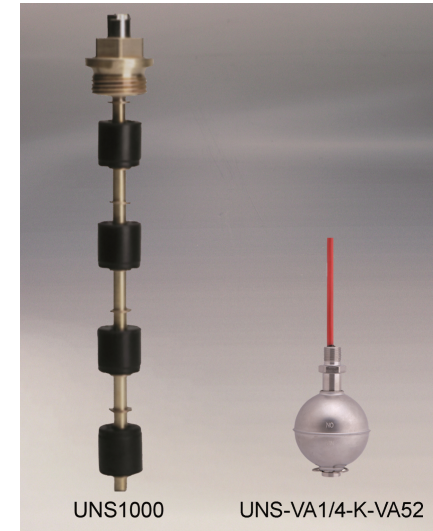

<b>1</b>	<b>Intended Applications</b> .....	<b>2</b>
<b>2</b>	<b>Safety Instructions</b> .....	<b>2</b>
<b>3</b>	<b>Standards</b> .....	<b>3</b>
<b>4</b>	<b>Warranty/Guaranty</b> .....	<b>3</b>
<b>5</b>	<b>Transport/Storage</b> .....	<b>3</b>
<b>6</b>	<b>Principle of Operation</b> .....	<b>4</b>
<b>7</b>	<b>Installation/Commissioning</b> .....	<b>4</b>
<b>8</b>	<b>Maintenance/Cleaning</b> .....	<b>9</b>
<b>9</b>	<b>Technical Data</b> .....	<b>10</b>

**Barksdale**  
CONTROL PRODUCTS

**Barksdale GmbH**  
Dorn-Assenheimer Straße 27  
D-61203 Reichelsheim

Phone: +49 (6035) 949-0  
Fax: +49 (6035) 949-111 and 949-113  
email: info@barksdale.de  
Internet: www.barksdale.de

Art. no.: 923-1940  
Index C, 24.06.2021



Specifications are subject to changes without notice!



## 1 Intended Applications

Barksdale level switches are approved exclusively for industrial applications. The level switches must not be used in situations in which human life depends on proper functioning of the device.

 <b>CAUTION</b>
The level switches may only be used in the specified fields of application (see type label). The temperature ranges must be within the permissible limits. The stated pressures and electrical load values must not be exceeded. Observe the applicable national safety instructions for assembly, commissioning and operation of the level switches.

 <b>CAUTION</b>
 When used in zone 0, the atmospheric pressure in accordance with EN 60079-0:2018, IEC 60079-0: 2017 must be between 0.8 and 1.1 bar absolute. If the level switch is used in a potentially explosive atmosphere outside the permissible pressure range, the type examination certificate serves only as a guideline.

 <b>DANGER</b>
Danger due to electrostatic discharge - Metallic process connection parts must be included in the local equipotential bonding (TÜV 18 ATEX 214370 X)

Every person installing, commissioning or operating Barksdale level switches must have read and understood these operating instructions.

## 2 Safety Instructions

The safety instructions are intended to protect the user from dangerous situations and/or material damage.

In the operating instructions the seriousness of the potential risk is designated by the following signal words:

 <b>DANGER</b>
Refers to imminent danger to men. Nonobservance may result in fatal injuries.

 <b>WARNING</b>
Refers to a recognizable danger. Nonobservance may result in fatal injuries, and destroy the equipment or plant parts.

 <b>CAUTION</b>
Refers to a danger. Nonobservance may result in light injuries and material damage to the equipment and/or to the plant.

 <b>IMPORTANT</b>
Refers to important information essential to the user.

 <b>Disposal</b>
The equipment must be disposed of correctly in accordance with the local regulations for electric/electronic equipment. The equipment must not be disposed of with the household garbage!

## 3 Standards

The standards applied during development, manufacture and configuration are listed in the CE conformity and manufacturer's declaration.

## 4 Warranty/Guaranty

### Warranty

Our scope of delivery and services is governed by the legal warranties and warranty periods.

### Terms of guaranty

We guaranty for function and material of the level switches under normal operating and maintenance conditions in accordance with the statutory provisions.

### Loss of guaranty

The agreed guaranty period will expire in case of:

- changes or modifications to the switch/housing/fitting
- incorrect use
- incorrect installation or
- incorrect handling or operation contrary to the provisions of these operating instructions

No liability is assumed for any damage resulting therefrom, or any consequential damage.

## 5 Transport/Storage

 <b>CAUTION</b>
Jolts and heavy vibrations must be avoided during transport. Storage should be dry and clean.

## 6 Principle of Operation

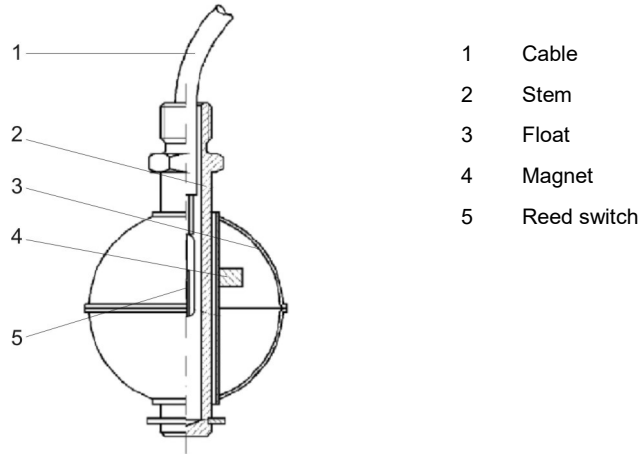

Figure 1: Sectional drawing - Level switch

All Barksdale level switches work according to the principle shown in picture 1.

A float equipped with magnets moves variably with the changing liquid level. The magnetic field of the float actuates a reed switch positioned inside the guide tube at a predefined place and closes or interrupts the current circuit.

If several level switching points are arranged in the stem various alarm functions can be triggered. By adding suitable relays the signals can be used in control system or for automatic pump control.

Advantages of these switching units: separation from the medium, no mechanical stress

## 7 Installation/Commissioning

 **IMPORTANT**

All level switches are tested for proper functioning before they leave the factory.

 **DANGER**

Prior to any work on electrical components disconnect them from power supply.

The electrical connection may only be made by trained expert staff!

The Barksdale level switches are supplied completely assembled. The level switches are installed through the tank top or bottom side. Sufficient distance must be kept to the tank wall and any installations. The float must move freely.

The Barksdale level switches should be installed vertically, if possible. Proper functioning is, however, guaranteed up to an inclination of 30°.

### Contact Protection

The values for current, voltage and power stated on the type label apply to purely resistive loads.

Frequently, lamp loads or the like should be switched as well. In these cases protection of the reed switches against voltage and current peaks must be considered.

Below some examples are shown concerning the wiring of reed switches for various loads to avoid premature failure.

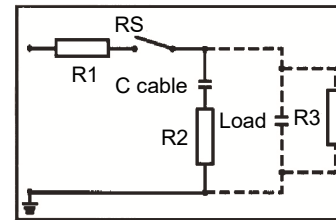

Figure 2: Protection in case of capacitive loads  
R1: Protection against start-up current rushes  
R2, R3: Protection against discharge currents

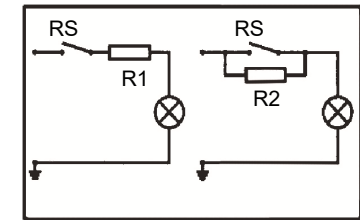

Figure 3: Lamp load with parallel or series resistor to switch

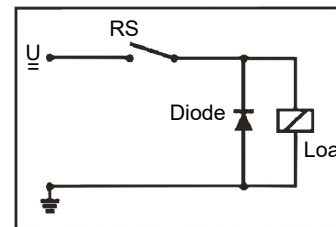

Figure 4: Protection at DC and inductive load by recovery diode

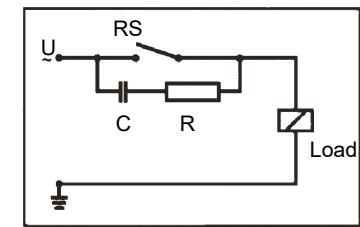

Figure 5: Protection at AC and inductive load by RC-link.

**Inductive Loads**

Direct current (DC): Connect recovery diode parallel to the load, see picture 4.  
Polarity must ensure that the diode will inhibit at normal operating voltage and short-circuit the opposite voltage peaks occurring when opening the switch.  
Alternating current (AC): Connect an RC unit parallel to the switch, see picture 5.  
Dimensioning of such an RC unit can be executed according to the nomogram shown in the picture:

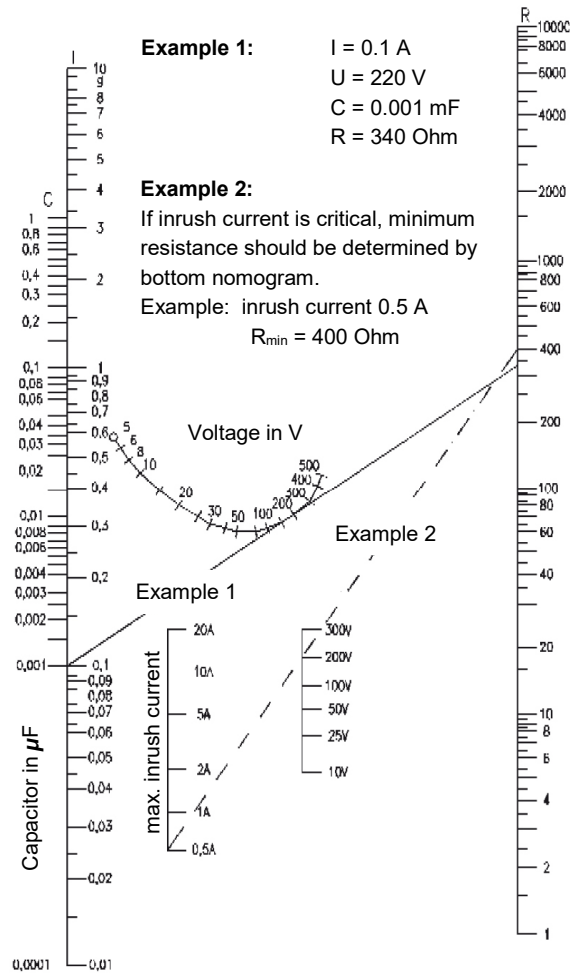

Figure 6: Nomogram for the determination of contact arc-dimming for inductive loads

**Capacitive Loads and Lamp Loads**

Increased inrush currents occur for capacitive loads and lamp loads. High inrush currents can lead to disturbances – even to fusing of contacts. During wiring of charged capacitors (e.g. cable capacities) a sudden discharge will occur. The discharge intensity depends on the capacity and length of the supply cable to the switch to be regarded as series resistor.

The discharge current peak is largely reduced by a series resistor. Its size is determined by the capabilities of the respective circuit. The series resistor should be as large as possible to limit the discharge current to a permissible value. These criteria apply analogously to the charging of capacitors, see picture 2.

Wiring lamp loads: The resistance value of cold lamp filaments (not switched on) is about ten times smaller than that of switched on lamp filaments. When the lamp is being switched on the current flow is for a short time ten times higher than in the glowing static state of the lamp. This tenfold inrush current can be reduced to a permissible value by a series-connected current limiting resistor. Parallel connection of a resistor to the switch is another option. The parallel resistor will permanently preheat the filament while the lamp is switched off just so far that it does not yet glow. Both protection systems result in the loss of power.

**Use in Hazardous Locations**

**Type of protection "I" intrinsic safety**

The level switches to be used in hazardous locations are principally designed for intrinsically safe circuits I following the applicable regulations and marked by the words **Ex Ia...** on the type plate.

They are only for use in an approved intrinsically safe circuit. The maximum values per circuit are stated on the type label.

See also page 12 of this document.

**Contact Wiring and Color Code**

**Group 1 SPST**

Terminal	Color
1	white
2	brown
3	green
4	yellow
5	grey
6	pink
7	blue
8	L5
9	L6

**Group 2 SPDT**

Terminal	Color
1	white
2	brown
3	green
4	yellow
5	grey
6	pink
7	blue
8	red
9	black

**Group 3 SPST**

	Terminal
L4	red 8
	blue 7
L3	pink 6
	grey 5
L2	yellow 4
	green 3
L1	brown 2
	white 1

**Group 4 SPDT**

	Terminal
L3	black 9
	red 8
L2	blue 7
	pink 6
L2	grey 5
	yellow 4
L1	green 3
	brown 2
L1	white 1

**NO (NC)**

	Terminal
L1	brown 2
	white 1

**Change over**

	Terminal
L1	green 3
	brown 2
L1	white 1

Temperature switches (TS or TP) and temperature sensors (PT100) are connected to the last contacts possible, unless otherwise specified.

**CAUTION**

Temperature switches (TS or TP) and temperature sensors (PT100) must be tested for functioning before commissioning.

**Connection UTS 2000**

	Terminal
L4	red 8
	blue 7
L3	pink 6
	grey 5
L2	yellow 4
	green 3
L1	brown 2
	white 1

**CAUTION**

- The following notes must absolutely be observed:
- The permissible data (see type label) must be kept.
  - The level switch must be protected against magnetic fields.
  - The sliding tube of the level switch must not be bent and severe shocks must be avoided, since otherwise the inert gas contacts (reed contacts) will be damaged.
  - Existing adjusting rings, gripping rings or clamping brackets must not be displaced since otherwise the SPST or SPDT function is no longer guaranteed.

The max. inrush power according to the data sheet is:

- for level switch – SPST – with 12 mm or 13 mm sliding tube 100 VA
- for level switch – SPDT – with 12 mm or 13 mm sliding tube 60 VA
- for level switch – SPST – with an 8 mm thick sliding tube 40 VA
- for level switch – SPST – with an 8 mm thick sliding tube 3 VA

These power values must not be exceeded since otherwise the switching contacts will fuse. A short circuit will immediately destroy the switching contact.

Long cables take a high capacitive charging current during switching-on. This charging current can be limited by a current limiting resistor of about 20 to 30 Ohm <1.W>. The resistor is installed in the connecting housing of the level switch.

Metal filament lamps take the three or four-fold of the current during switching-on. Level switches with a switching power of e. g. 100 VA can only switch 25 W filament lamps. This must be taken into account when a filament lamp is used for a continuity check.

When switching direct voltages, a diode must be connected in parallel with inductive consumers, such as relays or solenoid valves, for spark suppression in locking direction.

Cable glands of level switches must be checked for tightness at the connecting housing and at the level switch to ensure that no spray water can penetrate.. If necessary seal by means of filler.

**8 Maintenance/Cleaning**

**WARNING**

Check the level switch regularly for functioning.  
If the level switch does not work properly, stop operation immediately!

**Maintenance**

The level switch requires no maintenance.

**Cleaning**

**CAUTION**

Do not bend or hit the stem when cleaning the guide tube!

Proceed carefully to remove medium residues from the guide tube, if necessary.

**9 Technical Data**

Model	UNS-MS1/8-BN25 UNS-VA1/8-VA27	UNS-VA1/4-VA52	UNS-VA / SB4 (without test function) UNS-VA / SB5 (with test function)
Installation position	from the top or from the bottom		on the side
Stem material	Brass CrNi steel 1.4571	CrNi steel 1.4571	CrNi steel 1.4571
Mounting material	G1/8 push-through fitting	G1/4 push-through fitting	Mounting traverse
Float	BN 25, Ø = 25 mm VA27, Ø = 27 mm	VA52, Ø = 52 mm	PE33, Ø = 33 mm
Float material	Buna N CrNi steel 1.4571	CrNi steel 1.4571	Polyethylene PE
min. medium density [g/cm³]	BN25: 0.57 VA27: 0.71	VA52: 0.78	0.8
Max. permissible pressure [bar]	15	40	3
Max. permissible temperature	80/100 °C 105/150 °C, CrNi steel	105/150 °C, CrNi steel	70 °C
Contact type	SPST (NO), SPST (NC), SPDT		SPST
Contact rating	40 VA/W SPST 5 VA/W / SPDT	100 VA/W SPST 60 VA/W / SPDT	40 VA/W SPST
Options	High-temperature version		Test device
Approval	on request, see <a href="http://www.barksdale.de">www.barksdale.de</a>		

Model	UNS-VA/SB1 (without test function) UNS-VA/SB (with test function)	UNS-PA16-PA18 UNS-PA1/2"NPT-PA18	UNS-PP16-PP18 UNS-PP1/2"NPT-PA18
Installation position	on the side		
Stem material	CrNi steel 1.4571	Polyamide 6.6	Polypropylene
Mounting material	Mounting traverse	M 16 x 2 1/2" NPT, G1/2	M 16 x 2 1/2" NPT
Float	VA52, Ø = 52 mm	Ø = 18 mm	
Float material	CrNi steel 1.4571	Polyamide 6.6	Polypropylene
min. medium density [g/cm³]	0.7		0.65
Max. permissible pressure [bar]	10	5	
Max. permissible temperature	80 °C	60 / 120 °C	60 / 90 °C
Contact type	SPST / SPDT	SPST	
Contact rating	100 VA/W SPST 60 VA/W / SPDT	60 VA/W	
Options	Test device	on request	
Approval	on request, see <a href="http://www.barksdale.de">www.barksdale.de</a>		

Model	UNS1000	UNS2000
Installation position	from the top or from the bottom	
Stem material	Brass, CrNi steel 1.4571	
Mounting material	Flange and screw connection	
Tightening torque	UNS1000-G (G1'): 40 ±5 Nm	
Float	BN25, Ø = 25 mm; VA27, Ø = 27 mm	BN30, Ø = 30 mm; VA52, Ø = 52 mm
Float material	Buna N, CrNi steel 1.4571	
min. medium density [g/cm³]	BN25: 0.57; VA27: 0.71	BN30: 0.60; VA52: 0.78
Max. permissible pressure [bar]	15	15, 40
Max. permissible temperature	80/100 °C, NBR foamed 105/150 °C, CrNi steel	80/100 °C, NBR foamed 105/150 °C, CrNi steel
Contact type	SPST (NO), SPST (NC), SPDT	
Contact rating	40 VA/W SPST; 5 VA/W / SPDT	100 VA/W SPST; 60 VA/W / SPDT
Options	High-temperature version, temperature sensor	
Approval	on request, see <a href="http://www.barksdale.de">www.barksdale.de</a>	

Electrical contact rating for optional thermo-switch: 12 / 24 V DC, 3.0 A



**CAUTION**

The fittings and flanges must be conductively connected with the tank and integrated in the potential equalization system.



**CAUTION**

If various electrical components (e. g. reed switch and temperature switch) are used in a level switch, the electrical values of the weakest component must be observed.

No different potentials must be used.

**Approval data for Ex I switches**

Approval:

Float switch with floats from Buna-N or other plastic material (PP,PE,PVC, PTFE or PA), as well as with ST1- plug:

 II 1 G Ex ia IIB T6 Ga  
II 1/2 G Ex ia IIB T6 Ga/Gb  
II 2 G Ex ia IIB T6 Gb  
II 1 D Ex ia IIIC T100°C Da

Limit switch and other float switch

II 1 G Ex ia IIC T6 Ga  
II 1/2 G Ex ia IIC T6 Ga/Gb  
II 2 G Ex ia IIC T6 Gb  
II 1 D Ex ia IIIC T100°C Da

Certificate no.:

TÜV 18 ATEX 214370 X Issue 01, IECEx TUN 17.0039 X

Permissible ambient temperature:

-40 °C ... +75 °C (with SI, PUR, FEP cable material)  
-20 °C ... +75 °C (with PVC and CR cable material)

Electrical data:

In type of protection intrinsic safety Ex ia IIB/IIC/IIIC  
Only for the connection to a certified intrinsically safe circuit.

Maximum values:

Ui = 28 V li = 125 mA Pi = 0.5 W

Effective internal capacitance

Ci = Capacitance of the permanently connected cable

Effective internal Inductance

Li = Inductance of the permanently connected cable

For the connected cable the following applies:

C<sub>c, wire/wire</sub> + C<sub>c, wire/screen</sub> ≤ 200 pF/m

L<sub>c</sub> ≤ 1 μH/m

Ci = Capacitance of 10 m connection cable = 2nF

Li = Inductance of 10 m connection cable = 10uF

Standards applied:

EN 60079-0 : 2018, IEC 60079-0: 2017

Explosive atmospheres – Part 0: General requirements

EN 60079-11 : 2012, IEC 60079-11: 2011

Explosive atmospheres – Part 11: Equipment protection by intrinsic safety “I”

EN 60079-26:2015, IEC 60079-26:2014

Explosive atmospheres – Part 26: Equipment with protection level EPL Ga



**CAUTION**

**Special conditions for use**

1. Metallic process connection parts have to be included in the local potential equalization. A good electrically conductive connection between float switch and system ground must be ensured.
2. For the use in IIC-areas that require EPL Ga each float switch and limit switch, must be installed and used in such a way that electrostatic charges through operation, maintenance and cleaning are excluded.
3. For the use in areas that require EPL Da all float switches and limit switch must be protected from strong charge generation mechanisms.
4. By using an aluminium terminal box KX4(C), KX8(C), KXP(C), KLS1(C) or KLS2(C) in areas that require EPL Ga, the danger of ignition by impact or friction must be excluded.
5. For EPL Ga/Gb applications and at risks by pendulum or vibration the respective parts of the float switches resp. the limit switch have to be secured effectively against these dangers.
6. For EPL Ga/Gb applications the medium tangent materials of the float switches resp. the limit switch have to be resistant to the media.
7. For EPL Ga/Gb applications the whole devices shall be mounted in a way that allows an installation that results in a sufficient tight joint (IP66 or IP67) or a flameproof joint (EN 60079-1) in the direction of the less endangered area.



**CAUTION**

The float switch is to be installed and used in such a way that electrostatic charges caused through operation, maintenance and cleaning are excluded.